

NSP622 10AX Light Switch



**20
YEAR
GUARANTEE**

A new take on traditional moulded wiring accessories manufactured in bright white Urea.

Technical Drawing

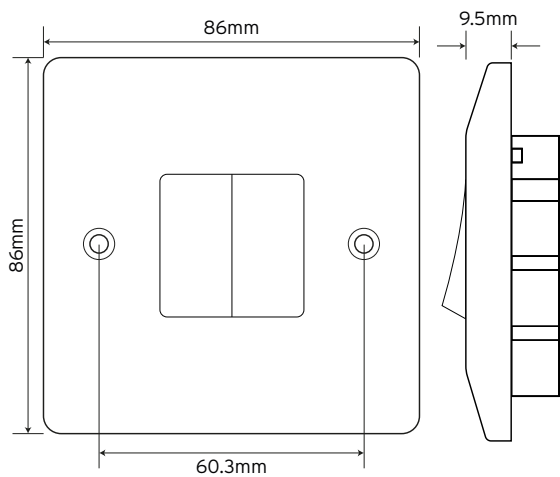

Technical Specifications

| | |
|---------------------------------|---|
| No. Gangs and Ways | 2 Gang, 2 Way |
| Material Composition | Front Plate - Urea Rear Housing - Nylon Terminals - Brass, Terminal Screws - Steel & Yellow Passivated Internal Mechanism - Formed Press Brass Silver "on-lay" Copper / Brass Contacts |
| Voltage | 240V~ 50Hz |
| Current Rating | 10AX (suitable for inductive loads) |
| Terminal Size | 3.5mm ϕ |
| Torque Value | 0.4Nm |
| Cable Size | 4 x 1.5mm ² or 2 x 2.5mm ² |
| Back Box Depth | 16mm |
| Modular | Yes |
| Warranty | 20 Years |
| Anti Microbial Certified | Yes |
| IP Rating | IP20 |
| Operational Temperature | -5° to +40° C |
| Standards | The Low Voltage Directive 2006/95/EC BS EN 60669-1:1999 + A1:2002 + A2:2008 Modified ISO 22196 |
| Dimensions | 86x86x9.5mm (HxWxD) |